



## Filtration

# The efficiency concept that makes the difference

## Compressed air filtration

- |                             |                            |                                 |                                |                          |
|-----------------------------|----------------------------|---------------------------------|--------------------------------|--------------------------|
| Архангельск (8182)63-90-72  | Ижевск (3412)26-03-58      | Магнитогорск (3519)55-03-13     | Пермь (342)205-81-47           | Сургут (3462)77-98-35    |
| Астана (7172)727-132        | Иркутск (395)279-98-46     | Москва (495)268-04-70           | Ростов-на-Дону (863)308-18-15  | Тверь (4822)63-31-35     |
| Астрахань (8512)99-46-04    | Казань (843)206-01-48      | Мурманск (8152)59-64-93         | Рязань (4912)46-61-64          | Томск (3822)98-41-53     |
| Барнаул (3852)73-04-60      | Калининград (4012)72-03-81 | Набережные Челны (8552)20-53-41 | Самара (846)206-03-16          | Тула (4872)74-02-29      |
| Белгород (4722)40-23-64     | Калуга (4842)92-23-67      | Нижний Новгород (831)429-08-12  | Санкт-Петербург (812)309-46-40 | Тюмень (3452)66-21-18    |
| Брянск (4832)59-03-52       | Кемерово (3842)65-04-62    | Новокузнецк (3843)20-46-81      | Саратов (845)249-38-78         | Ульяновск (8422)24-23-59 |
| Владивосток (423)249-28-31  | Киров (8332)68-02-04       | Новосибирск (383)227-86-73      | Севастополь (8692)22-31-93     | Уфа (347)229-48-12       |
| Волгоград (844)278-03-48    | Краснодар (861)203-40-90   | Омск (3812)21-46-40             | Симферополь (3652)67-13-56     | Хабаровск (4212)92-98-04 |
| Вологда (8172)26-41-59      | Красноярск (391)204-63-61  | Орел (4862)44-53-42             | Смоленск (4812)29-41-54        | Челябинск (351)202-03-61 |
| Воронеж (473)204-51-73      | Курск (4712)77-13-04       | Оренбург (3532)37-68-04         | Сочи (862)225-72-31            | Череповец (8202)49-02-64 |
| Екатеринбург (343)384-55-89 | Липецк (4742)52-20-81      | Пенза (8412)22-31-16            | Ставрополь (8652)20-65-13      | Ярославль (4852)69-52-93 |
| Иваново (4932)77-34-06      | Киргизия (996)312-96-26-47 | Казахстан (772)734-952-31       | Россия (495)268-04-70          |                          |

<http://beko.nt-rt.ru> || [bko@nt-rt.ru](mailto:bko@nt-rt.ru)

# Safety means, as far as we are concerned, we never rely on chance

- › Particle deposition
- › Oil vapour adsorption
- › Aerosol deposition



### Protect plants, systems and processes

Compressed air must be freed of aerosols, oil and particles before it enters your application. The contamination resulting from the ambient air and compressor operation can damage your plant or system and ruin the product. CLEARPOINT® compressed air filters ensure the purity of your compressed air – safely and efficiently.

### Identify savings potentials and utilise them

80% of the life-cycle costs for a compressed air plant result from operating costs. The energy costs for the compressor are also a considerable factor. A pressure drop in the system must be compensated for by higher compressor performance in order to maintain the operating pressure. The consequence: increased energy requirement and premature compressor wear. Appropriate compressed air filtration creates increased energy saving potential in this area.

### Developing reliable solutions

CLEARPOINT® compressed air filters utilise this enormous saving potential with innovative 3eco filter elements and a special housing design. We can provide you with the right solution for every requirement by utilising our comprehensive compressed air filter programme and our extensive know-how.















- › Flange and threaded filters  
16 bar Pages 6 – 8
- › Activated carbon filter Page 10
- › Water separator Page 11
- › High pressure filter  
50 bar Pages 12 – 13  
100 – 500 bar Pages 14 – 15
- › Sterile and vapour filters Pages 16 – 17

Filter stages	 Water separator CLEARPOINT® W  H <sub>2</sub> O	 Coarse Filter CLEARPOINT® C  25 µm 4 . - . 4	 Fine filter CLEARPOINT® F  1 µm 2 . - . 2	 Ultra-fine filter CLEARPOINT® S  0.01 µm 1 . - . 2*	 Activated carbon filter CLEARPOINT® A/V  Oil vapour Odours - . . 1	 Sterile filter CLEARPOINT® SR  Bacteria, viruses, Micro-organisms	 Vapour filter CLEARPOINT® ST  25 – 1 µm
<b>Compressed air class (ISO 8573-1)</b>							
<b>Pressure level</b> Up to 16 bar Pages 6– 11	■	■	■	■	■	■	■
<b>50 bar</b> Pages 12– 13	■	■	■	■	■		
<b>100 – 500 bar</b> Pages 14– 15		■	■	■	■		

\* Class 1 can also be achieved depending on ambient and operating conditions

# Always the best possible compressed air quality

Depending on the required compressed air quality, several compressed air filters are often connected or switched in series throughout the entire processing chain. In such cases it is not only the efficiency of every individual filter which is decisive for an economical, reliable and safe overall system, rather more the right combination. We can develop the solution which is suitable for you and your demands – for all compressed air qualities according to ISO 8573-1!

<b>Coarse filtration / Class 4 . - . 4</b>						
Fluid and solids deposition for non-critical applications	Water separator CLEARPOINT® W <b>H<sub>2</sub>O</b>	Coarse Filter CLEARPOINT® C <b>25 µm</b>				
<b>Fine filtration / Class 2 . - . 2</b>						
For general deposition of condensate and particles for dryers, valves, fittings and tools	Water separator CLEARPOINT® W <b>H<sub>2</sub>O</b>	Coarse Filter CLEARPOINT® C <b>25 µm</b>	Fine filter CLEARPOINT® F <b>1 µm</b>			
<b>Ultra-fine / Class 1 . - . 2*</b>						
Combination for safe separation of condensate, oil aerosols and particles, recommended for demanding applications with higher requirements	Water separator CLEARPOINT® W <b>H<sub>2</sub>O</b>	Fine filter CLEARPOINT® F <b>1 µm</b>	Ultra-fine filter CLEARPOINT® S <b>0.01 µm</b>			
<b>Oil-free and odour-free air / Class 1 . - . 1 .</b>						
High-performance filtration for deposition of all pollutants up to and including oil vapours and odours for applications with the highest requirements (pre-drying the air is necessary)	Water separator CLEARPOINT® W <b>H<sub>2</sub>O</b>	Fine filter CLEARPOINT® F <b>1 µm</b>	Ultra-fine filter CLEARPOINT® S <b>0.01 µm</b>	Activated carbon filter CLEARPOINT® A/V <b>Oil vapour, odours</b>	Dust filter CLEARPOINT® RS <b>0.01 µm</b>	Sterile filter CLEARPOINT® SR <b>Bacteria, viruses, Micro-organisms</b>

\* Class 1 can also be achieved depending on the operating conditions (aspiration air, ambient temperature, type of compressor, type of oil etc.).

Multifunctional

Cost saving

Clean

Safe



Water separator

High pressure filter  
100 - 500 bar

Flange and threaded filters  
up to 16 bar

High pressure filter  
Up to 50 bar

# Up to 16 bar

Filter stages							
	Water separator CLEARPOINT® W	Coarse Filter CLEARPOINT® C	Fine filter CLEARPOINT® F	Ultra-fine filter CLEARPOINT® S	Activated carbon filter CLEARPOINT® A/V	Sterile filter CLEARPOINT® SR	Vapour filter CLEARPOINT® ST
	H <sub>2</sub> O	25 µm	1 µm	0.01 µm	Oil vapour Odours	Bacteria, viruses, Micro-organisms	25 – 1 µm
Compressed air class (ISO 8573-1)		4 . - . 4	2 . - . 2	1 . - . 2*	- . - . 1		
Pressure level Up to 16 bar	■	■	■	■	■	■	■

\* Class 1 can also be achieved depending on ambient and operating conditions

## Optimised, efficient, validated: CLEARPOINT® Filter up to 16 bar

Lower operating costs, longer service life, higher process safety and multifunctional application capability – just some of the many advantages from our CLEARPOINT® Filter. Irrespective of whether aerosols or solid particles, dust, oil vapour and odours or water: CLEARPOINT® 3eco filter elements have been optimised for materials and manufacturing technology. They are more efficient for safely removing contamination from the compressed air. All quality classes can now be achieved meaning you always have the required compressed air quality for the respective application.

# CLEARPOINT® flange and threaded filters: the best connection

Depending on the plant specifications, CLEARPOINT® filters are available with robust aluminium housings and threaded connections or as a welded container with flange connection for larger performance ranges.

- › Achieve the desired compressed air quality with very low pressure differences
- › Efficient filtration between 30 and 130 % (threaded filter) and/or 111 % (flange filter) for nominal performance
- › Large fibre surface with higher cavity volumes
- › Increased process safety by utilising up to 10 fold increased oil aerosol deposition percentages
- › Able to fulfil all compressed air filtration requirement with just 3 degrees of filtration

## Flange filter

- › Flange connection for inlet/outlet at the same height
- › Housing concept with blind flange at the top enables service-friendly filter element exchange
- › Installation: Integration in pipework as well as possibility for wall mounting or positioning on adjustable feet
- › Impressively simple handling concept filter element/filter element bracket
- › Optional: Differential manometer for evaluation
- › Connection for BEKOMAT® condensate drain
- › Performance range from 1,420 to 34,680 m<sup>3</sup>/h at 7 bar

## Threaded filter

- › Finely adjusted construction size concept for performance and connection
- › Flow-optimised filter inlet and filter outlet
- › Doubled trapezoidal thread: simple alteration for through flow direction
- › Slide feed concept generates acoustic signal, when the device is opened under pressure
- › Simple handling for filter exchange with push-fit technology
- › Connection possibility for BEKOMAT®
- › Performance range from 35 to 3,120 m<sup>3</sup>/h at 7 bar

CLEARPOINT® Flange filter with BEKOMAT®



CLEARPOINT® Threaded filter with BEKOMAT®



# CLEARPOINT® 3eco – lower operating costs with optimised pressure difference

The decisive factor when evaluating the service life costs for compressed air filters is the energy consumption which results from pressure difference. The new CLEARPOINT® 3eco filter elements can reduce the pressure difference by up to 50%. The CLEARPOINT® 3eco filter lowers the operating costs considerably more when compared to the previous, already efficient, CLEARPOINT® 3E filters. They not only increase the process safety but also the separation efficiency.

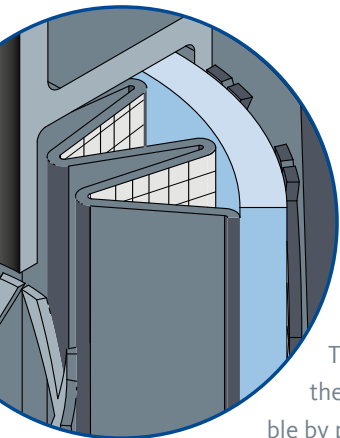
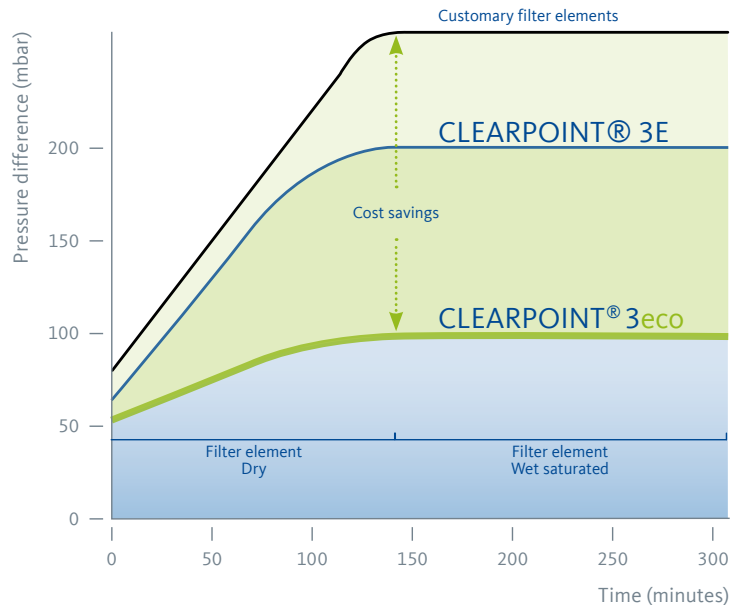

## New material and production processes makes this possible

The significant performance increase with the CLEARPOINT® 3eco filter is made possible by pioneering materials: An innovative open synthetic fleece (mesh) on the outside of the filter media ensures the

required rigidity for the various filter positions, without thereby reducing the filter surface area. The innovative production method utilising soft-pleat technology provides optimum connection for many surfaces and larger filter bed depth.

## Perfect interaction for highest quality

We always think about holistic solutions as a system provider. For this reason, we always develop every component for the compressed air processing plant as part of an interactive team comprising filtration, condensate management and drying. This guarantees process safety for the entire plant. CLEARPOINT® filters not only perform their contribution with 3eco filter elements, but also with sophisticated housing technology.

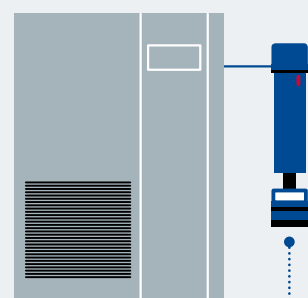



# The Tried and Tested Filter Housing with the Practice Oriented Details

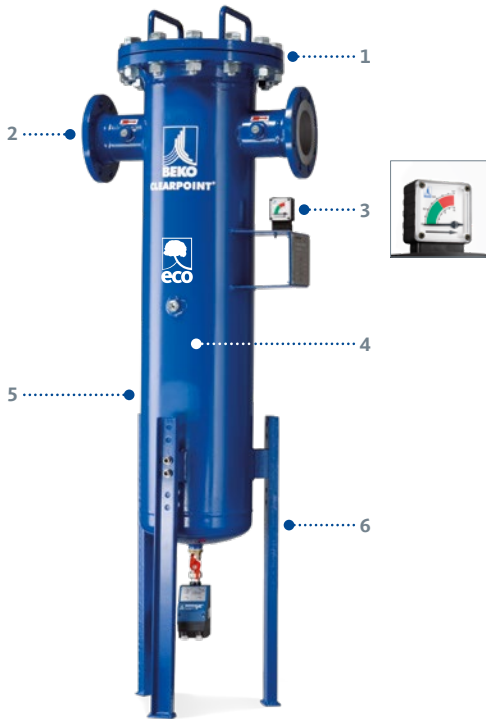

- 1 Service-friendly filter element exchange by simple accessibility on top blind flange
- 2 Simple installation with two same-height compressed air connections
- 3 Optional differential manometer indicates whether the filter unit must be exchanged – ideal to retain the energy costs at a low level.
- 4 Impressively simple handling concept with filter element/filter element bracket
- 5 High-quality surface protection by utilising high-temperature galvanising on the inside and paint on the outside
- 6 Flange filter can not only be integrated in the pipework but also with adjustable feet on the container and anchored on the floor

- 1 Quick and easy to use wall mounting (optional)
- 2 Multiple filter stages save space and are simple to assemble
- 3 Flow efficient air inlets for the lowest possible pressure losses
- 4 Simple and rapid filter element exchange with push-fit design
- 5 Doubled trapezoidal thread for rapid and safe assembly as well as directional change for flow through
- 6 Secured slide feed prevents inadvertent opening under pressure
- 7 Corrosion protected housing made of anodised, sea water resistant aluminium
- 8 Connection possibility for condensate drain such as e.g. BEKOMAT®
- 9 Integrated key aid (external hexagonal) for easy opening of the housing

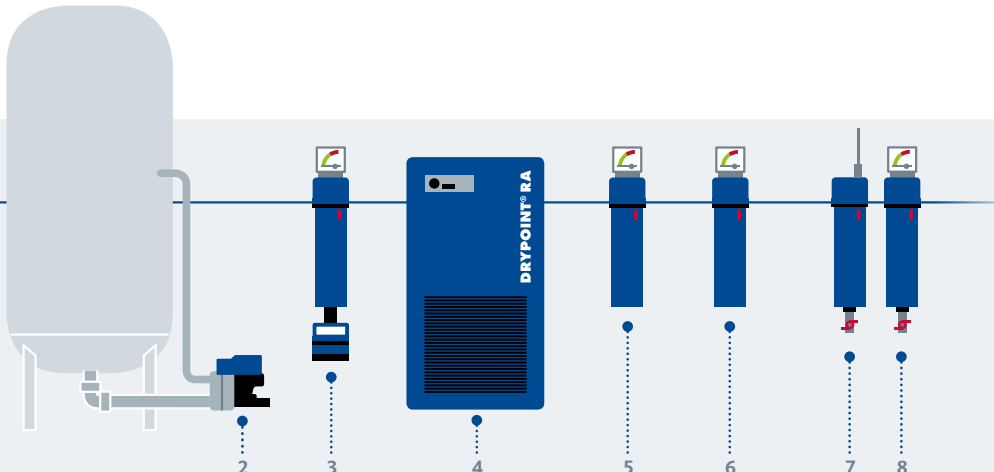
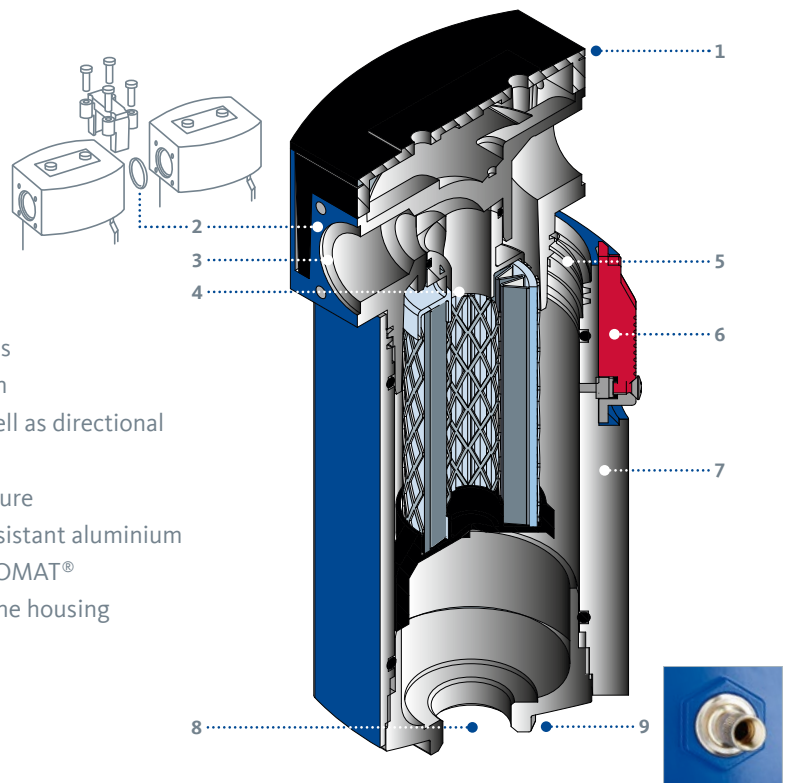

- 1 CLEARPOINT® W Water separator with BEKOMAT® condensate drain
- 2 BEKOMAT® Condensate drain
- 3 CLEARPOINT® C Coarse filter
- 4 DRYPOINT® RA Refrigeration dryer
- 5 CLEARPOINT® F Fine filter
- 6 CLEARPOINT® S Ultra-fine filter
- 7 CLEARPOINT® A/V Activated carbon filter
- 8 CLEARPOINT® RF Ultra-fine dust filter

# CLEARPOINT® A/V Activated carbon filter: measurable improved results

## Activated carbon filter with cartridge

- › For smaller volume flows
- › Highly efficient adsorption with residual oil content below  $0.003 \text{ mg/m}^3$
- › Longer service life compared to conventional filter elements
- › Service-friendly with easy to exchange cartridge
- › Almost abrasion free with integrated particle separation
- › Simple to adapt oil inspection indicator



CLEARPOINT® V  
Activated carbon cartridge



CLEARPOINT® V  
Activated carbon adsorber

## Activated carbon adsorber

- › For larger volume flows
- › Perfect compressed air quality with a maximum residual oil content of  $0.003 \text{ mg/m}^3$
- › Reduced operating costs by utilising low pressure difference and long service life
- › Complete solution with oil-free dust filter

# Highest possible water separation percentages: with CLEARPOINT® W

It is not possible to prevent condensate from occurring in compressed air systems – the consequences which result in costs can however be prevented: Utilising a CLEARPOINT® W water separator, for example directly downstream of the after cooler, creates maximum separation percentages and subsequent filtration will be relieved.

## Highest possible separation percentages

- › Process safe particle and condensate separation
- › 99% separation percentage with very low pressure difference already with 30% of the maximum volume flow
- › Flow optimised design with special swirl disc, innovative rectifier and rising pipe
- › BEKOMAT® for optimum condensate discharge
- › Validated aligned to ISO 12500-4

## Safe and durable

- › Very effective corrosion protection by utilising a housing design made of seawater resistant aluminium (anodised and powder coated externally)

## Simple handling

- › Rapid assembly and dismantling as well as simple filter exchange is possible with doubled trapezoidal thread
- › Space saving connection possibilities for sequential connections of multiple filters



CLEARPOINT® W

## Process safety and highly-efficient water separation

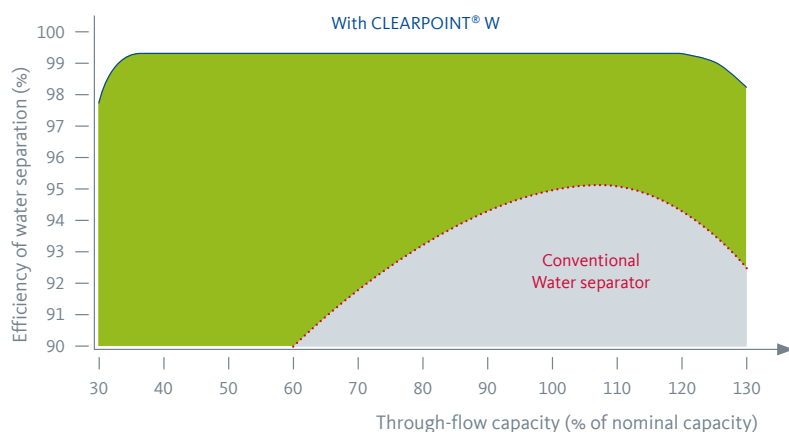

The CLEARPOINT® W with flow-optimised design achieves an efficiency of up to 99% over a wider performance range – for highest possible separation-percentages with lowest costs.

# Up to 50 bar

Compressed air class (ISO 8573-1)	Filter stages							
	Water separator CLEARPOINT® W	Coarse Filter CLEARPOINT® C	Fine filter CLEARPOINT® F	Ultra-fine filter CLEARPOINT® S	Activated carbon filter CLEARPOINT® A/V	Sterile filter CLEARPOINT® SR	Vapour filter CLEARPOINT® ST	
	H <sub>2</sub> O	25 µm	1 µm	0.01 µm	Oil vapour Odours	Bacteria, viruses, Micro-organisms	25 – 1 µm	
		4 . - . 4	2 . - . 2	1 . - . 2*	- . - . 1			
50 bar	■	■	■	■	■			

\* Class 1 can also be achieved depending on ambient and operating conditions

## Clean performance under high pressure: CLEARPOINT® Filter up to 50 bar

High-pressure systems create particular challenges for all components. Our CLEARPOINT® high-pressure filter provides a decisive added value in such cases: Its construction and design are imple-

mented in all details for highest possible operating safety, also under high pressure, and ensures an optimum for separation performance.

## High corrosion resistance



Seawater resistant aluminium optimally protects the streamlined housing against corrosion – exactly like the complete anodising and externally applied additional powder coating. CLEARPOINT® high-pressure filters are therefore also resistant to aggressive condensate.

# Safe and high-performance capable

## Safety improved

Piston compressors cause system-related pulsations in the compressed air flow, resulting in vibrations that can cause leaks in conventional filter housings. CLEARPOINT® filter housings remain leak tight due to a lockable screw sliding disc. Furthermore, it also prevents every unintentional opening of the housing: A clear warning signal is issued when attempting to open it under pressure.

## Optimal with BEKOMAT®

CLEARPOINT® high-pressure filters can be connected with the electronically level regulated BEKOMAT® 12 PN63 with self-monitoring for safe condensate discharge. The condensate drain operates reliably without pressure loss and enables remote monitoring with a potential-free contact.



## Impressive in many industrial areas



Laser cutting plants

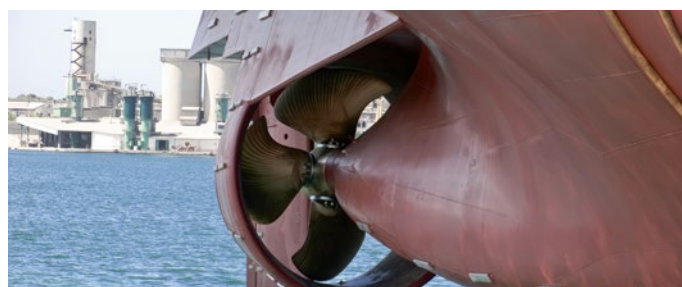

Auxiliary start up for ship diesel engines



Production for PET bottles

CLEARPOINT® high-pressure filters fulfil the requirements for many industrial areas with applications up to a volume flow of 3,500 m<sup>3</sup>/h. With their seawater resistant alloying and very long service duration they can also cope with aggressive condensates e.g. for marine shipping.

# 100 to 500 bar

Filter stages							
	Water separator CLEARPOINT® W	Coarse Filter CLEARPOINT® C	Fine filter CLEARPOINT® F	Ultra-fine filter CLEARPOINT® S	Activated carbon filter CLEARPOINT® A/V	Sterile filter CLEARPOINT® SR	Vapour filter CLEARPOINT® ST
<b>Compressed air class (ISO 8573-1)</b>	H <sub>2</sub> O	25 µm	1 µm	0.01 µm	Oil vapour Odours	Bacteria, viruses, Micro-organisms	25 – 1 µm
		4 . - . 4	2 . - . 2	1 . - . 2*	- . - . 1		
<b>100 – 500 bar</b>							

\* Class 1 can also be achieved depending on ambient and operating conditions

## Designed for harsh conditions CLEARPOINT® Filter 100 up to 500 bar

As the pressure increases, the requirements for the compressed air filtration and utilised devices also increase. With a particularly robust housing and higher temperature resistance of up to 120 °C,

the CLEARPOINT® high-pressure filter provides numerous technical and economical advantages for reliable separation of solid material contamination, aerosols, oil vapours and odours.

## The complete facilities for highest possible safety



**No corrosion, no impairment for filter performance, no thread fretting**  
All metallic components are made of stainless steel as standard production.



**Radial sealing housing O-ring**  
Advantage: no destruction of the O-ring during element exchange (danger when utilising axial-type O-ring seals).



**Provision for economic element exchange.**  
Standard feature (as of S 045) with connection for differential manometer.



**Additional securing against loosening the housing screw connection from pulsating volume flow**  
Lateral clamping screw prevents the lower part of the housing from screwing out.



**Element exchange easily done in confined spaces**  
Element connection either with screwthread (up to S 040) or with plug-in connector (as of S 045). No constriction for flow cross section e.g. with tension rod.



**Comprehensive, complete documentation for traceability**  
Acceptance certification according to DIN EN 10204. Embossed serial and batch numbers on housing parts.

# Stands up to **all** requirements

## Quality in every detail

The housing, filter element caps and support cylinder of our high-pressure filter are produced from stainless steel – for good reasons: This enables us to prevent corrosion and guarantee a very long service duration, also with aggressive condensates.

CLEARPOINT® high-pressure filters are available for pressure stages 100, 350 and 500 bar, optional with manual drain off and differential manometer.



## Totally reliable

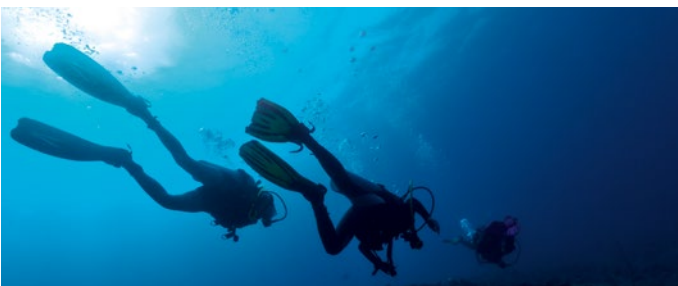

**Diving bases**



**Shipping**



**Oil platforms**

Higher pressure, confined spaces, aggressive ambient conditions: CLEARPOINT® high-pressure filters operate safely under all conditions and also impress with their service advantages – such as the simple and safe element exchange, even with less space, by utilising screwed thread or plug-in connection.

# Sterile and vapour filter

Compressed air class (ISO 8573-1)	Filter stages	
	 Sterile filter CLEARPOINT® SR Bacteria, viruses, Micro-organisms	 Vapour filter CLEARPOINT® ST 25 – 1 µm
Pressure level Up to 16 bar	■	■
50 bar		
100 – 500 bar		

## Purity according to food standards: CLEARPOINT® Sterile and vapour filters

More and more industrial applications require germ-free compressed air, also under harsh conditions. Alongside the higher retention efficiency for bacteria, viruses and additional micro-organisms, the other most important factor is to achieve high through-flow percentages with lower pressure differences. The separation performance must be ensured even with minimum work load for the filter.

CLEARPOINT® sterile filters fulfil these requirements and are internationally approved for indirect contact with food according to FDA CFR Title 21 and 1935/2004/EC. In order to ensure that sterile filter remains sterile, it must be sterilised at regular intervals with saturated steam. Our solution: CLEARPOINT® vapour filter. The sterile and vapour filters share one housing made of high-quality, flow-optimised stainless steel for the highest possible process safety.

## The vapour sterilisation

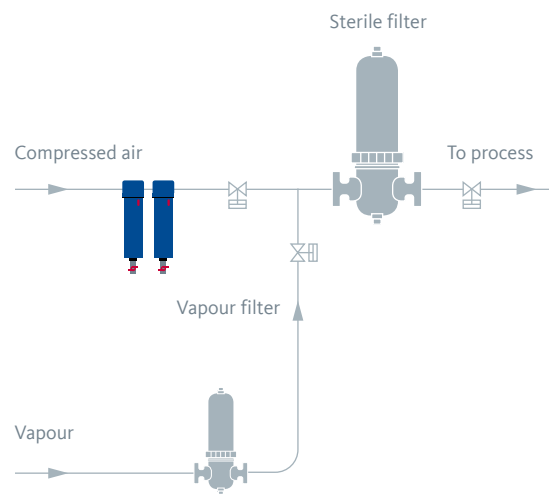

Vapour sterilisation in direct flow; Flow direction from hot vapour through the sterile filter is identical with the through-flow direction for compressed air.

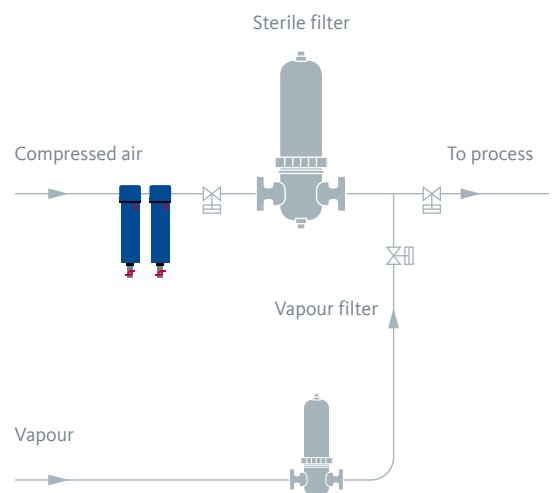

Vapour sterilisation in counter flow: Flow direction from hot vapour through the sterile filter is opposite to the through-flow direction for compressed air.



# An impressive system

## Filter housing

- › All components comply with FDA CFR Title 21 and 1935/2004/EC
- › High-quality stainless steel, suitable for contact with food
- › Connection for condensate drain and venting valve
- › 12 different installation sizes

## CLEARPOINT® Sterile filter

- › Germ-free hygiene
- › Complies with cGMP requirements
- › High dirt collection capacities with lower pressure differences
- › Maximum separation performance also with minimum work load
- › Up to 100 sterilisation cycles are possible

## CLEARPOINT® vapour filter

- › Increased vapour quality extends the service duration for the sterile filter
- › Porosity degree > 50%
- › Higher through-flow percentages with lower pressure difference
- › Can be regenerated with return flushing and ultrasound
- › Also suitable for culinary vapour



## Hygiene at the highest level



**Food industry**



**Beverage industry**



**Pharmaceutical industry**

CLEARPOINT® sterile filters are an impressive solution for sensitive areas like the food industry, in dairies and breweries, but also in the chemical and pharmaceutical industries: suitable and approved for indirect contact with food, can be utilised up to 180 °C (356 °F) and are particularly durable by utilising CLEARPOINT® vapour filters – both integrated in one, high-quality stainless steel housing.

# Everything from one source for your success!

When it comes to compressed air, no two applications are exactly the same. Every application creates its own very individual requirements for the compressed air quality. That is where our solutions come into their own! For more than three decades, we have represented high-performance, worldwide tried and tested compressed air and compressed gas technologies. For products, systems and solutions, which ensure the desired quality in the production processes for our customers and make them more efficient. From filtration and drying to condensate technology up to, and including, instruments for quality controlling and verification. From small compressed air plants to sophisticated process technology. We are the only supplier in the market offering all components found along the processing chain. For our products, we use only components that meet our stringent quality standards. Through dedication and expert knowledge, we are able to combine these components for optimum efficiency and reliability.



## Condensate technology



## Compressed air generator

As soon as the compressed air leaves the compressor, it must be processed and treated very specifically for the most varied applications.



## Excellent service

For us, customer service means that we assist our customers from the first moment of contact, during the planning and commission phase and when the system is up and running. We help you in all matters regarding cleaning, maintenance, measuring

and training: We are there for you for the entire service life of our products, offering you a wide range of services.

## Application

Our solutions create holistic solutions to ensure the required quality for every application.

### Drying



### Olievrij



## BEKO TECHNOLOGIES

### Measurement technology



### Filtration

The correct solution for all requirements and quality classes – by utilising a large product programme of highly-efficient filter technology. CLEARPOINT® filters from **BEKO TECHNOLOGIES** impress with lower energy costs, longer service life, excellent process safety and safe filtration of aerosols, oil and dust – up to 500 bar and particularly efficient by utilising the innovative 3eco filter elements.

Архангельск (8182)63-90-72  
Астана (7172)727-132  
Астрахань (8512)99-46-04  
Барнаул (3852)73-04-60  
Белгород (4722)40-23-64  
Брянск (4832)59-03-52  
Владивосток (423)249-28-31  
Волгоград (844)278-03-48  
Вологда (8172)26-41-59  
Воронеж (473)204-51-73  
Екатеринбург (343)384-55-89  
Иваново (4932)77-34-06

Ижевск (3412)26-03-58  
Иркутск (395)279-98-46  
Казань (843)206-01-48  
Калининград (4012)72-03-81  
Калуга (4842)92-23-67  
Кемерово (3842)65-04-62  
Киров (8332)68-02-04  
Краснодар (861)203-40-90  
Красноярск (391)204-63-61  
Курск (4712)77-13-04  
Липецк (4742)52-20-81  
Киргизия (996)312-96-26-47

Магнитогорск (3519)55-03-13  
Москва (495)268-04-70  
Мурманск (8152)59-64-93  
Набережные Челны (8552)20-53-41  
Нижний Новгород (831)429-08-12  
Новокузнецк (3843)20-46-81  
Новосибирск (383)227-86-73  
Омск (3812)21-46-40  
Орел (4862)44-53-42  
Оренбург (3532)37-68-04  
Пенза (8412)22-31-16  
Казахстан (772)734-952-31

Пермь (342)205-81-47  
Ростов-на-Дону (863)308-18-15  
Рязань (4912)46-61-64  
Самара (846)206-03-16  
Санкт-Петербург (812)309-46-40  
Саратов (845)249-38-78  
Севастополь (8692)22-31-93  
Симферополь (3652)67-13-56  
Смоленск (4812)29-41-54  
Сочи (862)225-72-31  
Ставрополь (8652)20-65-13  
Россия (495)268-04-70

Сургут (3462)77-98-35  
Тверь (4822)63-31-35  
Томск (3822)98-41-53  
Тула (4872)74-02-29  
Тюмень (3452)66-21-18  
Ульяновск (8422)24-23-59  
Уфа (347)229-48-12  
Хабаровск (4212)92-98-04  
Челябинск (351)202-03-61  
Череповец (8202)49-02-64  
Ярославль (4852)69-52-93